



Multiple
position
switches
FMV

General features

The **FMV** series vertical mounting multiple position switches, are an important accessory in the automatic production process for monitoring the moving parts of a machine. Due to their limited dimensions in proportion to the functions performed, the multiple position switches offer the ideal solution to command automatic machines. The body of the multiple position switches is made of die cast metal alloy, while the roller plunger actuators are made of tempered steel.

Two different mounting brackets:

- 100 (130 for the start of the first actuators at 30 mm)
- 200 (230 for the start of the first actuators at 30 mm)

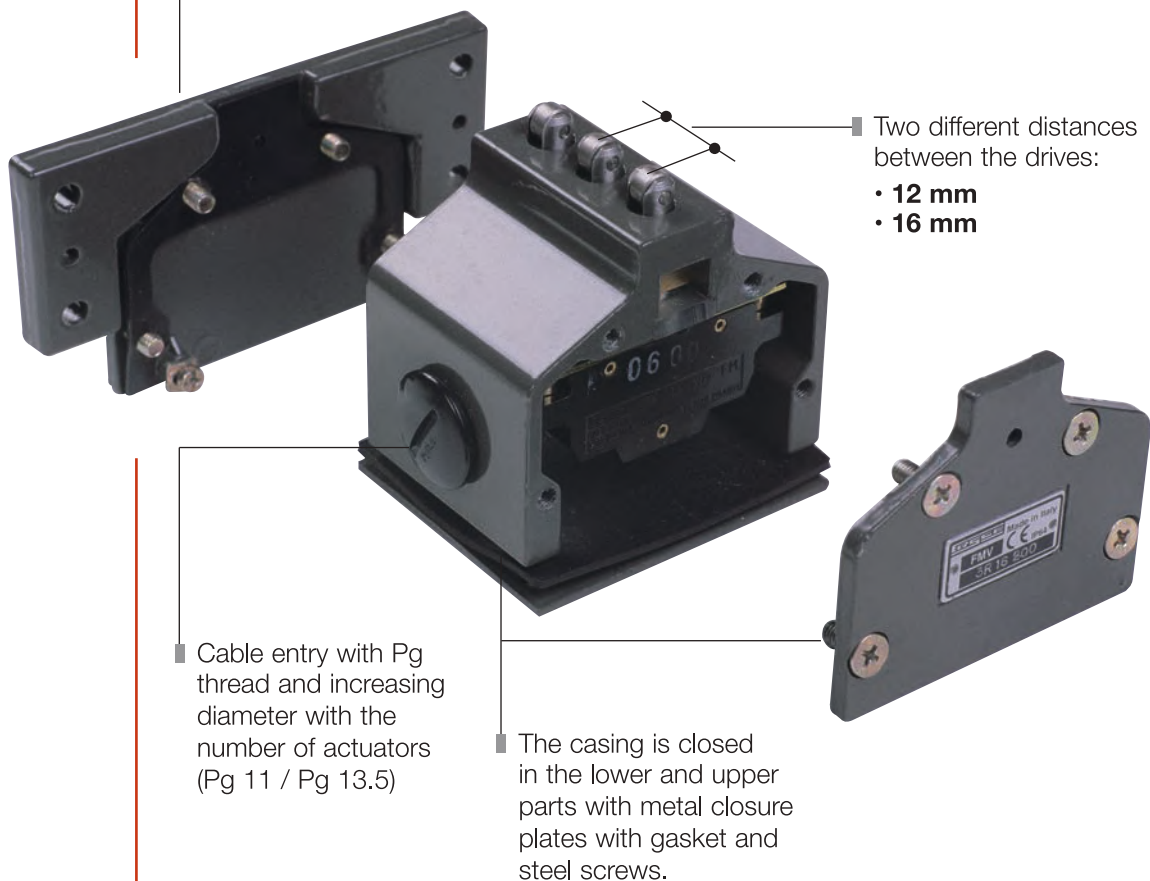

Technical data

			TYPE	FMV		
Maximum operating frequency		operat./hour ¹		1800		
Insulation resistance		500 V DC	MΩ	100		
Dielectric strenght		50/60 Hz for 1'	V AC	2000 ²		
Rated insulation voltage	Ui	IEC947-5-1	V AC	500		
Rated thermal current	Ithe	IEC947-5-1	A	10		
Rated operating current	Category AC15 A300	le IEC947-5-1/EN60947-5-1	24V	A	10	
			125V	A	10	
			230 V	A	6	
			400 V	A	4	
Contact resistance		IEC255-7 cat.3	initial value	mΩ	25	
Short circuit protective devices		IEC269 (IEC947-5-1)				
		fuse type gL or gG	A		10	
Pollution degree		IEC947-5-1	A		3	
Protection degree		EN 60529			IP64	
Protection against electric shock		metal	class		I	
Vibration resistance		IEC68-2-6	mm		0,35 ± 15%	
					(10 ÷ 55 Hz ± 1 Hz)	
Shock resistance		IEC68-2-27	11ms	g	30	
Mechanical life				cycles	30.000.000	
Electric life		at 250V AC 6A with resistance load cosφ=1		cycles	500.000	
		at 250V AC 6A with inductive load cosφ=0,4		cycles	500.000	
Terminals	Type				Screw with combined notch and retractable plate (notch Ph. Size 1)	
	Screw				M3,5	
	Material				Steel class 8,8 / Galvanized	
	Max. screw tightening torque		Ncm (Kg cm)		120 (12,24)	
	Max connecting capacity	rigid cable		mm ²		2x1,5
		flexible cable		mm ²		2x1,5
	with prod terminal				1x1,5	
Terminal numbering					In accordance with EN50013	
Air ambient temperature		operational		°C	-10 ÷ +70 (without formation of ice)	
Relative umidity		operational			95% max	

¹ One operation cycle means two movements, one to close and one to open as required by EN 60947-5

² Between terminals with different polarity; between live mechanical parts and ground; between live mechanical parts and non-current-carrying metal parts

Operating characteristics

Roller side travel

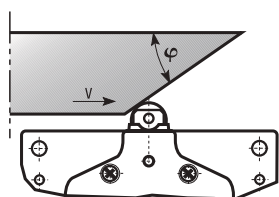

Drive cam operating parameters

φ	V max (m/s)
30°	1
20°	1,5

Drive forces

Minimum command force	10 N
Minimum force on lateral travel	18 N



Start 30
Pitch 12



Vertical mounting bracket 100

Contact element	
snap action 1NO+1NC 	FM

standard article

Metal	No. of roller actuators	Weight (kg)	Pack (pcs)	Travel diagram
FMV2R12130	2 R	0,421	1	
FMV3R12130	3 R	0,523	1	
FMV4R12130	4 R	0,621	1	

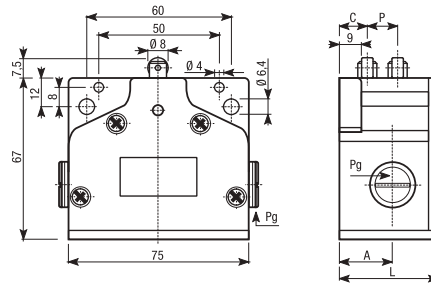

Characteristics

Distance between the actuators 12 mm, start 30 mm

Code	No. of actuators	P	C	L	Pg	A
FMV2R12130	2	12	30	54	11	30
FMV3R12130	3	12	30	66	13,5	35
FMV4R12130	4	12	30	78	13,5	35

Notes:

- P = Pitch (distance between two actuators)
- C = Distance between bracket and first actuator
- L = Overall dimensions
- A = Distance between bracket and input/output holes

Start 30
Pitch 12



Vertical mounting bracket 200

Contact element	
snap action 1NO+1NC	
	FM

standard article

Metal	No. of roller actuators	Weight (kg)	Pack (pcs)	Travel diagram
FMV3R12230	3 R	0,563	1	
FMV4R12230	4 R	0,662	1	

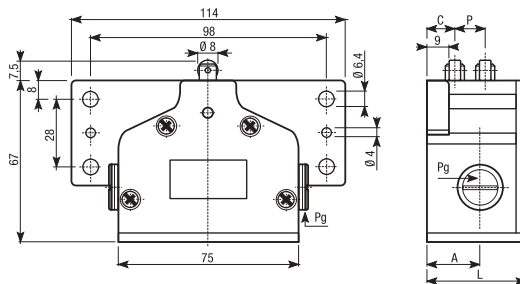

Characteristics

Distance between the actuators 12 mm, start 30 mm

Code	No. of actuators	P	C	L	Pg	A
FMV3R12230	3	12	30	66	13,5	35
FMV4R12230	4	12	30	78	13,5	35

Notes:
 P = Pitch (distance between two actuators)
 C = Distance between bracket and first actuator
 L = Overall dimensions
 A = Distance between bracket and input/output holes

Start 30
Pitch 16



Vertical mounting bracket 100

Contact element	
snap action 1NO+1NC	
	FM

standard article

Metal	No. of roller actuators	Weight (kg)	Pack (pcs)	Travel diagram
FMV2R16130	2 R	0,470	1	
FMV3R16130	3 R	0,584	1	

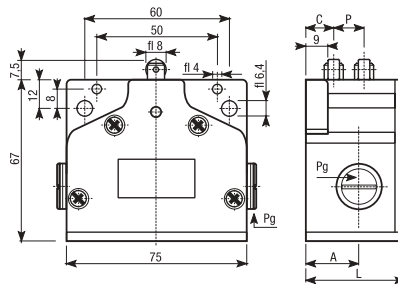

Characteristics

Distance between the actuators 16 mm, start 30 mm

Code	No. of actuators	P	C	L	Pg	A
FMV2R16130	2	16	30	62	11	30
FMV3R16130	3	16	30	78	13,5	35

Notes:

- P = Pitch (distance between two actuators)
- C = Distance between bracket and first actuator
- L = Overall dimensions
- A = Distance between bracket and input/output holes

Start 30
Pitch 16



Vertical mounting bracket 200

Contact element	
snap action 1NO+1NC	
	FM

standard article

Metal	No. of roller actuators	Weight (kg)	Pack (pcs)	Travel diagram
FMV3R16230	3 R	0,629	1	
FMV4R16230	4 R	0,748	1	

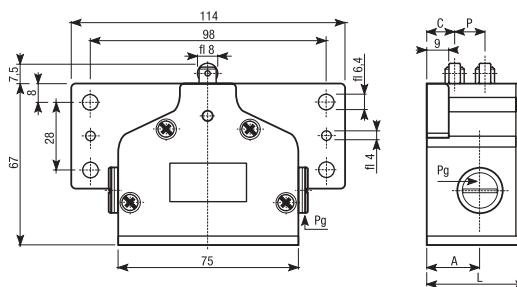

Characteristics

Distance between the actuators 16 mm, start 30 mm

Code	No. of actuators	P	C	L	Pg	A
FMV3R16230	3	16	30	78	13,5	35
FMV4R16230	4	16	30	94	13,5	35

Notes:

- P = Pitch (distance between two actuators)
- C = Distance between bracket and first actuator
- L = Overall dimensions
- A = Distance between bracket and input/output holes

Start 12
Pitch 12



Vertical mounting bracket 100

Contact element	
snap action 1NO+1NC 	FM

Metal	No. of roller actuators	Weight (kg)	Pack (pcs)	Travel diagram
FMV1R100	1 R	0,266	1	
FMV2R12100	2 R	0,363	1	
FMV3R12100	3 R	0,455	1	
FMV4R12100	4 R	0,528	1	

standard article

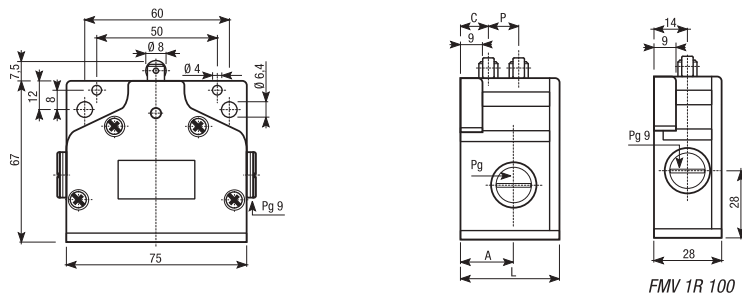

Characteristics

Distance between the actuators 12 mm, start 12 mm

Code	No. of actuators	P	C	L	Pg	A
FMV2R12100	2	12	12	41	11	22
FMV3R12100	3	12	12	53	13,5	30
FMV4R12100	4	12	12	60	13,5	30

Notes:

- P = Pitch (distance between two actuators)
- C = Distance between bracket and first actuator
- L = Overall dimensions
- A = Distance between bracket and input/output holes

Start 16
Pitch 16

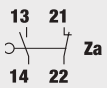
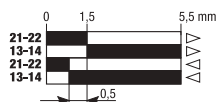
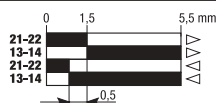
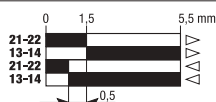

Vertical mounting bracket 100

Contact element	Metal	No. of roller actuators	Weight (kg)	Pack (pcs)	Travel diagram
snap action 1NO+1NC 	FMV2R16100	2 R	0,405	1	
	FMV3R16100	3 R	0,521	1	
	FMV4R16100	4 R	0,642	1	

standard article

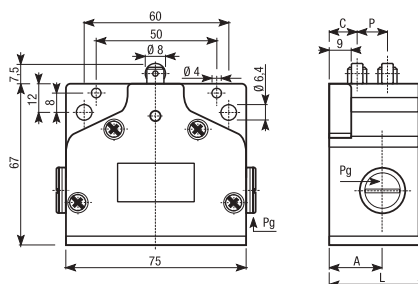

Characteristics

Distance between the actuators 16 mm, start 16 mm

Code	No. of actuators	P	C	L	Pg	A
FMV2R16100	2	16	16	48	11	22
FMV3R16100	3	16	16	64	13,5	30
FMV4R16100	4	16	16	80	13,5	30

Notes:

- P = Pitch (distance between two actuators)
- C = Distance between bracket and first actuator
- L = Overall dimensions
- A = Distance between bracket and input/output holes