

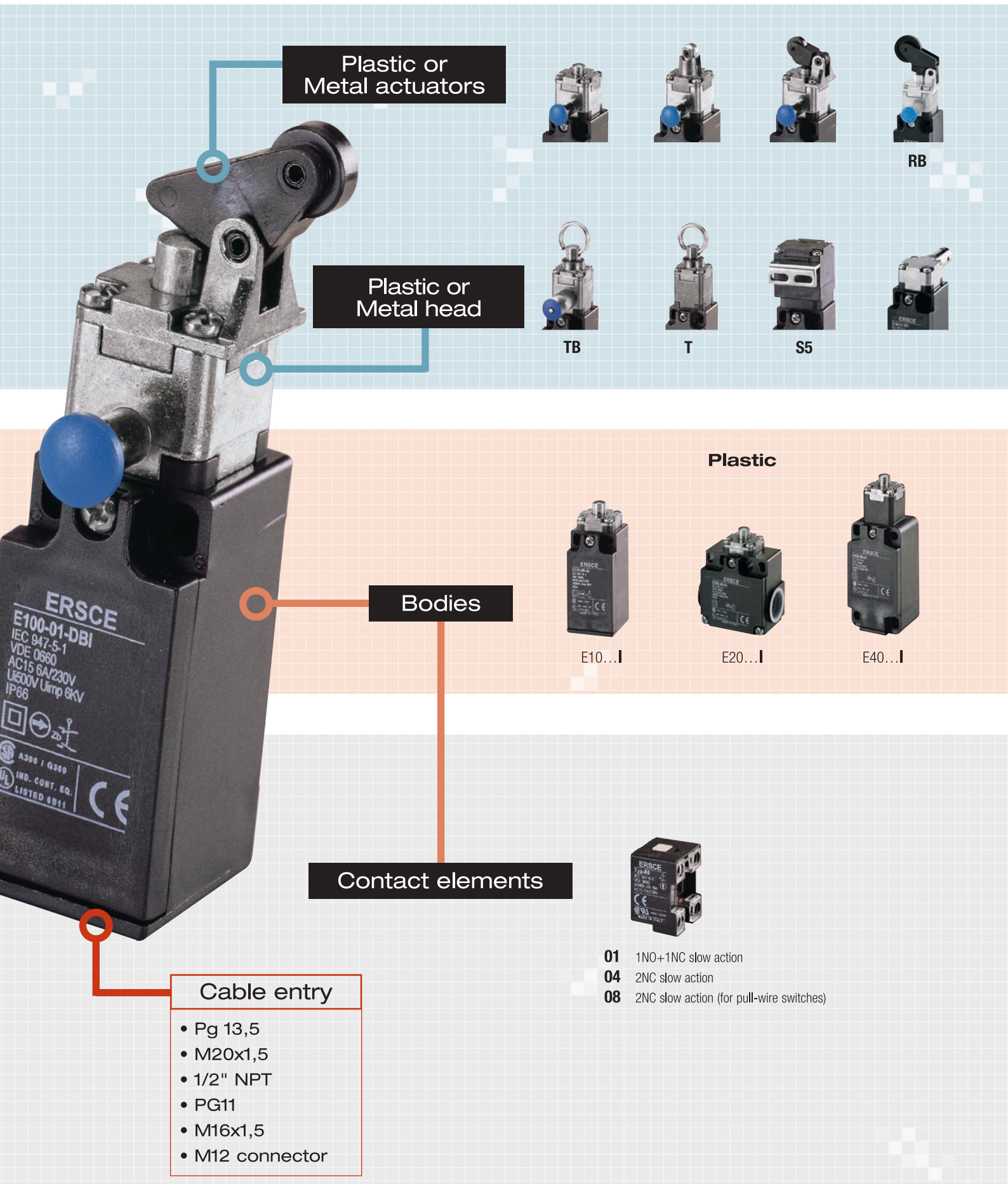

Safety switches

# Selection diagram







DB



EB



IB



IB•50



FB



FB•50

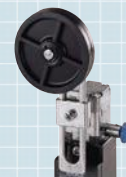

FBR•50

**Metal**



E10...M



E30...M



E40...M

**Product code structure**

**E10 0 01 FB I 50**

**Series**

- E10** 1 cable entry
- E20** 2 cable entry
- E30** 3 cable entry
- E40** 4 cable entry

**Ingresso cavi**

- 0** PG 13,5
- 1** M20x1,5
- 2** 1/2" NPT
- 3** PG 11
- 4** M16x1,5

**Contact element**

- 01** 1NO+1NC slow action
- 04** 2NC slow action
- ...

**Opzioni**

- 50** With Ø50 mm roller
- P** With cable gland Pg13,5
- Q** With cable gland Pg11
- M12** With M12 connector
- R** With membrane M20x1,5

**Construction material**

- I** Plastic body / Metal head
- M** Metal body / Metal head

**Actuator type**

- AB** Steel plunger with reset
- BB** Steel roller plunger with reset
- ...

Note: Please verify the effective availability of a product before ordering.



## Technical data

		TYPE	E100 / E200 / E300 / E400
Maximum operating frequency		operat./hour <sup>1</sup>	3600
Insulation resistance		500 V DC MΩ	100
Dielectric strenght		50/60 Hz for 1 <sup>1</sup> V AC	2500 <sup>2</sup>
Rated insulation voltage	Ui	IEC947-5-1 V AC	500
Rated thermal current	Ithe	IEC947-5-1 A	10
Rated operating current	Category AC15 A300	le IEC947-5-1/EN60947-5-1 24V A	10
		125V A	6
		230 V A	6
		400 V A	3
Contact resistance	IEC255-7 cat.3	initial value mΩ	25
Short circuit protective devices	IEC269 (IEC947-5-1) fuse type gL or gG	A	10
Rated conditionals short circuit current	IEC947-5-1	A	1000
Pollution degree	IEC947-5-1	A	3
Protection degree	EN 60529		IP66
Protection against electric shock		plastic class	II
		metal class	I
Vibration resistance	IEC68-2-6	mm	0,35 ± 15% (10 ÷ 55 Hz ± 1 Hz)
Shock resistance	IEC68-2-27	11ms	g
Mechanical life			cycles
Electric life	at 250V AC 6A with resistance load cosφ=1		cycles
	at 250V AC 6A with inductive load cosφ=0,4		cycles
Distance between contacts	Snap action type	mm	2x1,25
	Low action type	mm	2x2
Terminals	Type		Screw with combined notch and retractable plate (notch Ph. Size 1)
	Screw		3,5
	Protection degree		IP20
	Material		Steel class 8,8 / Galvanized
	Max screw tightening torque		120 (12,24)
	Max connecting capacity	rigid cable	mm <sup>2</sup>
flexible cable		mm <sup>2</sup>	2x1,5
Terminal numbering			In accordance with EN50013
Air ambient temperature		operational °C	-35 ÷ +85 (without formation of ice)
Relative umidity		operational	95% max

<sup>1</sup> One operation cycle means two movements, one to close and one to open as required by EN 60947-5.

<sup>2</sup> Between terminals of the same polarity; between terminals with different polarity; between live mechanical parts and ground; between live mechanical parts and non-current-carrying metal parts.







## Certifications and Approvals

			IEC EN 60947
E100	•	•	+
E200	•	•	+
E300	•	•	+
E400	•	•	+

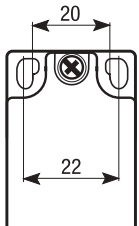
- UL approval file E72861
- CSA approval file 026716-0-000
- Approved
- + Conforms to requirements

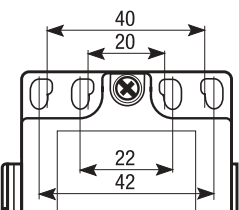
**E100-E200  
E300-E400  
series**

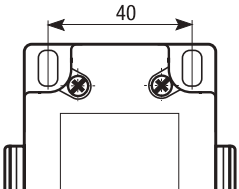

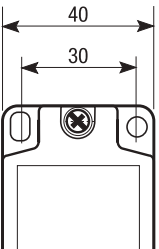



- Plastic or Metal body
- Plastic\* or Metal head and actuators
- IP66 protection degree
- Contact elements with positive opening of the NC contact in accordance to IEC EN 60947-5-1 and VDE 0660-200

Series	Product	Fixing holes
E100		
E200		
E300		
E400		

\* On key actuated switches

## Cable inputs/outputs

Series	Nr.
E100	1 on the bottom 
E200	2 on the sides 
E300	2 on the sides + 1 on the bottom 
E400	1 on the bottom 

Type	Series
Pg 13,5 	Ex00..
M20x1,5 	Ex01..
1/2 NPT 	Ex02..
Pg 11 	Ex03..
M16x1,5 	Ex04..
M12 connector 	Ex00.. <b>M12</b>

## Actuation heads

## ■ Safety switches with reset

## Group AB-BB



**AB**  
Plunger



**BB**  
Roller plunger



**CB**  
Plastic roller lever,  
side actuation



**RB**  
Reversible  
and adjustable lever  
with plastic roller



**DB**  
Plastic roller lever,  
vertical actuation

## Group EB-IB-FB-FRB



**EB**  
Straight lever  
with plastic roller



**IB**  
Bent lever  
with plastic roller



**IB•50**  
Bent lever  
with Ø50mm  
rubber roller



**FB**  
Variable length  
lever with plastic  
roller



**FB•50**  
Variable length  
lever with Ø50mm  
rubber roller



**FRB•50**  
Adjustable lever  
with Ø50mm  
rubber roller

## ■ Key actuation safety switches

## Group S5



**S5**  
5 ways keys  
actuation

## ■ Pull wire safety switches

## Group T



**TB**  
Pull wire  
with reset



**T**  
Pull wire  
without reset

## ■ Hinges operating safety switches

## Group SC



**SC**  
Metal pin

## Contact elements

### Protective screen

Protective natural polycarbonate screen to prevent the entry of materials and access to the test finger (IP20 – EN60529)

### Mobile and fixed contacts

Ag/Ni mobile and fixed contacts galvanically separated (acc. IEC 947-5-1, EN 60204, VDE 0660, VDE 0113)



Contact unit	Actuator	Group AB-BB	Group CB-RB	Group DB	Group EB-IB-FB-FRB	Group S5	Group T	Group SC
<b>01</b> 1NO+1NC slow action	1NO+1NC slow action  21 13 22 14							
<b>04</b> 2NC slow action	2NC slow action  11 21 12 22							
<b>08</b> 2NC slow action	2NC slow action  11 21 12 22							

Opened contact

Closed contact

Pressure of the switch / Release of the switch



## General characteristics

Safety switches are conceived for applications related to the protection of automated installations and are available in 4 different product families: with reset, pull-wire, 5 way key and for hinge actuation.

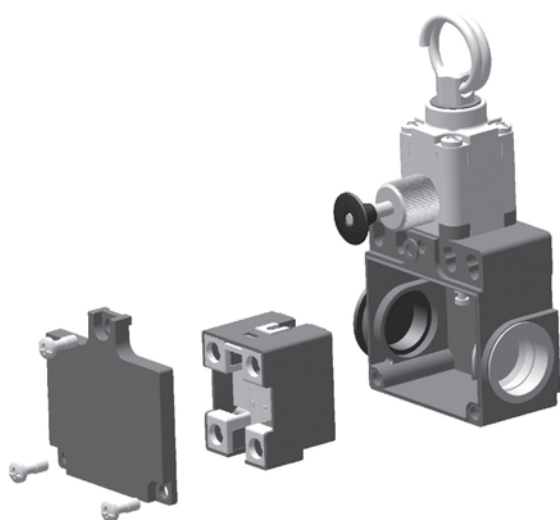

- thermoplastic or metal body
- IP66
- contact blocks with positive opening of the NC contact according to IEC EN 60947-5-1 e VD 0660-200

### Adjustable levers

Possibility to adjust the lever in  $10^\circ$  steps for  $360^\circ$  by moving the lever and the dragging device.

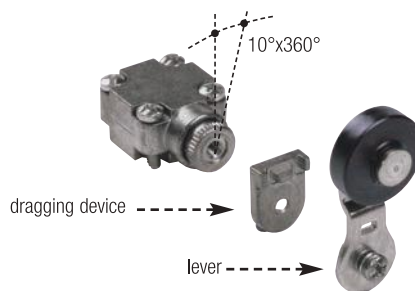

### Overturning levers

all the levers can be fastened on switches on straight or reverse side, to obtain two different work plans of the lever.

